

Je kunt het systeem configureren zowel vóór als na installatie. Plugwise zoneverwarming bestaat uit:

# plugwise

## Softwareinstallatie

## Configuratie zoneverwarming

in de lokale webinterface



Adam HA (incl. Zigbee-stick), die installeer je bij de ketel.



Radiatorknoppen, die installeer je op alle radiatoren (vloerverwarmingsdelen en/of convectieputten) in de ruimtes die je wilt voorzien van zoneverwarming.



Lisa, die plaats je in alle ruimtes die je wilt voorzien van zoneverwarming.

Volg hiervoor de stappen in de handleiding van de producten.

## Stap 1 - Open de lokale webinterface van Adam

Optie A - Adam is nog niet verbonden met het internet

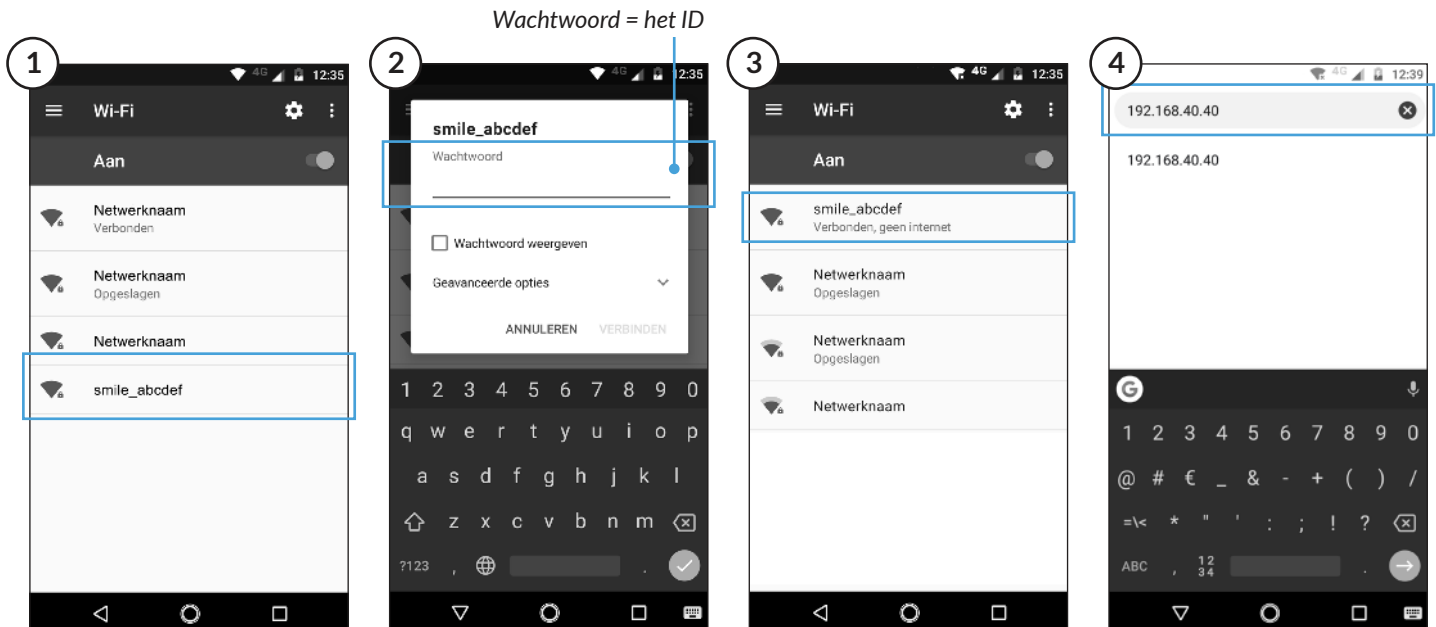

Optie B - Adam is verbonden met het internet

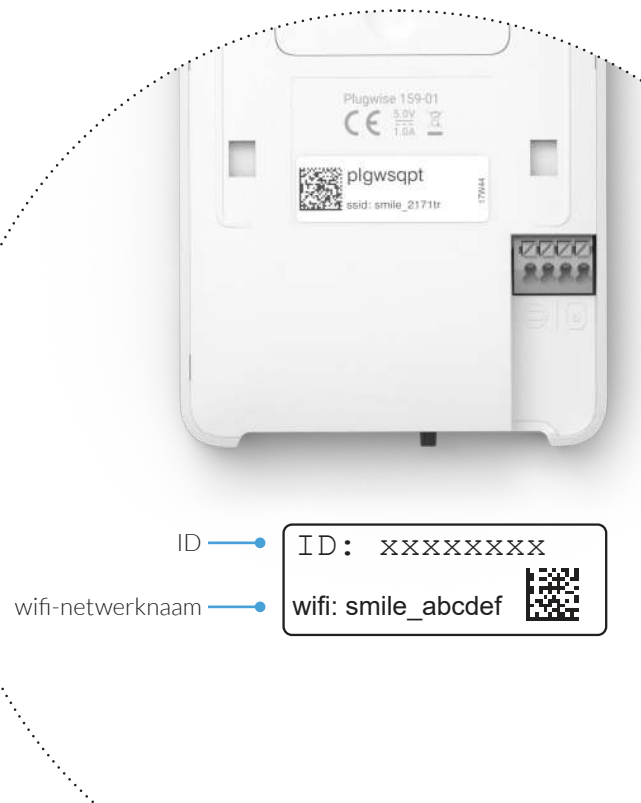
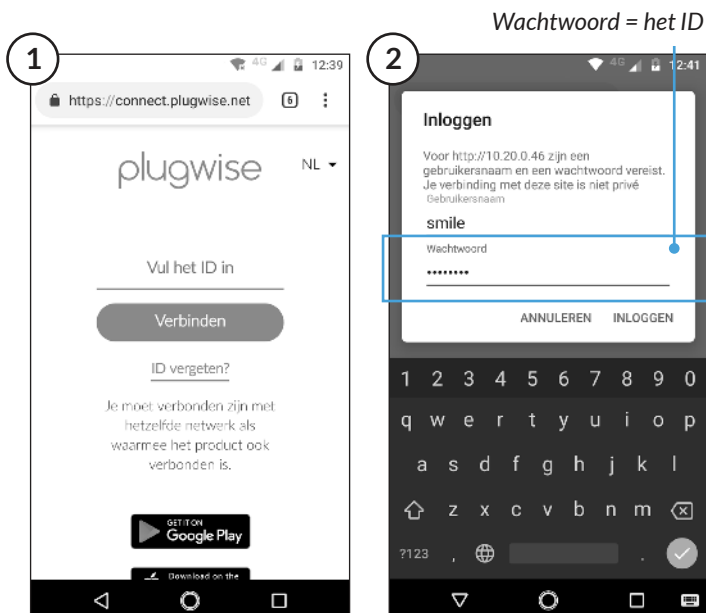

# Stap 2 - Configureer het systeem in de lokale webinterface van Adam



Installatie zonder OpenTherm-thermostaat

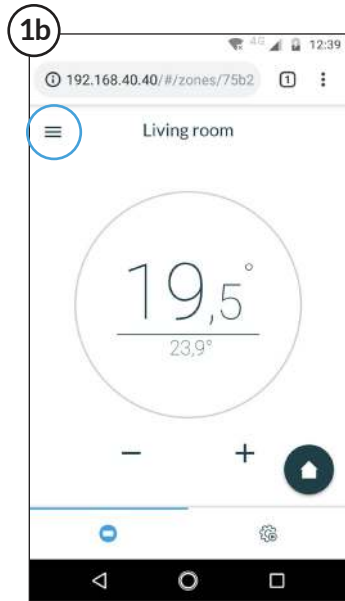

Installatie met OpenTherm-thermostaat

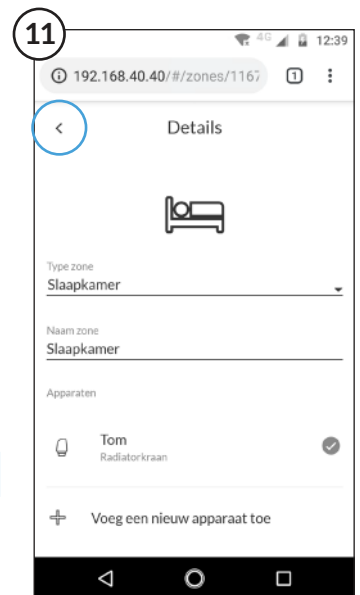
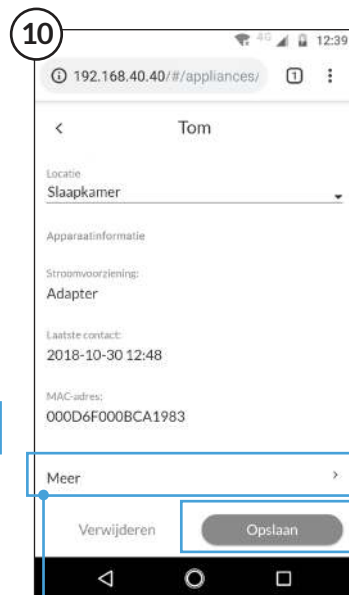
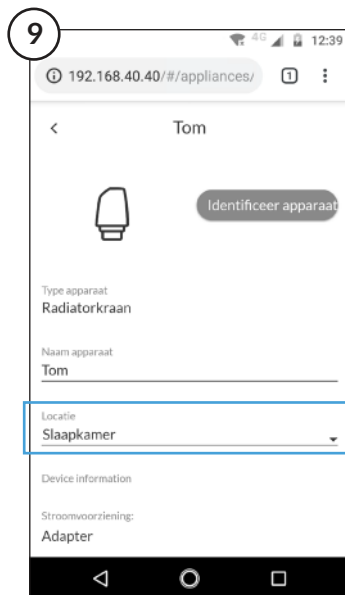
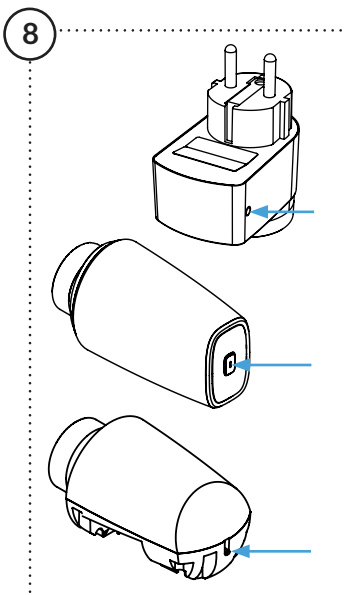
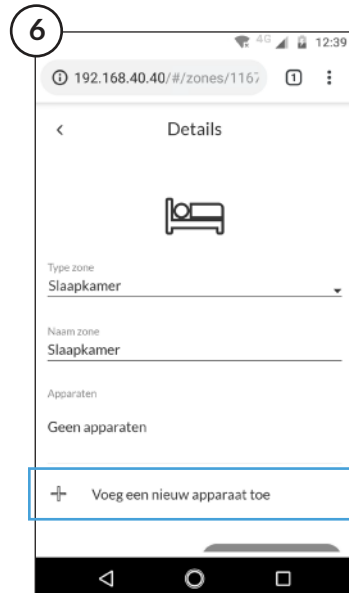
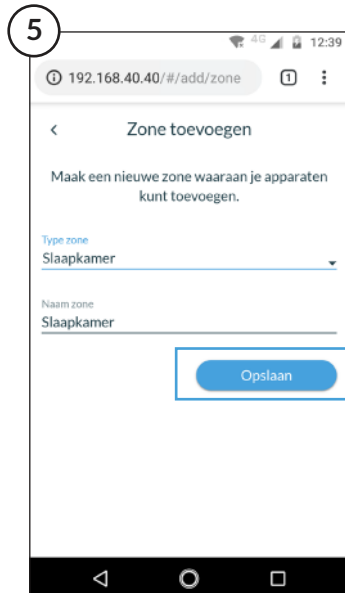
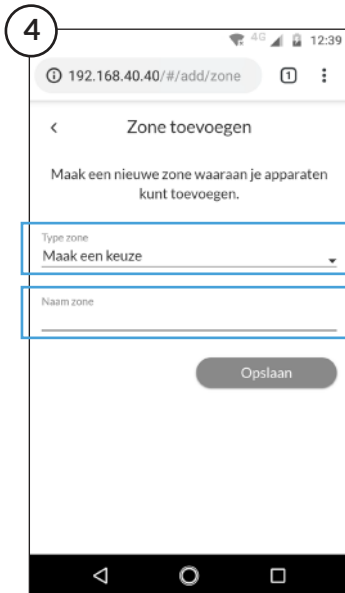
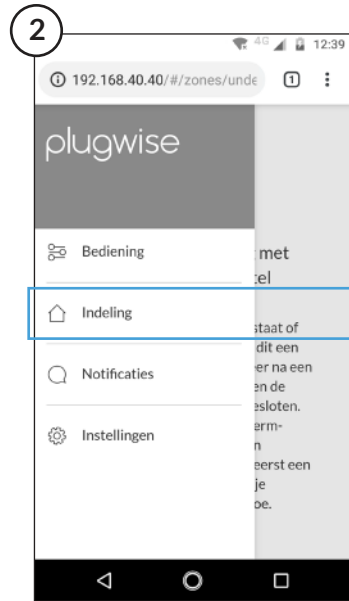

Technische informatie en functionaliteiten